

AIR FRYER

USER'S GUIDE



Model: KDF-4610DTW

Introduction

Thank you for buying this top-quality air fryer. You will now be able to cook a wide assortment of food in a healthier manner, with little or no oil!

In combination with high-speed air circulation, the air fryer uses hot air and a top grill to prepare your dishes quickly and easily. The ingredients are heated from all sides and there is no need to add oil in most cases.

General description

- A/D: Rack
- B/E: The tray
- C/F: Basket handle
- G: Air inlet
- H: Control panel
- I: Vent windows
- J: Power cord

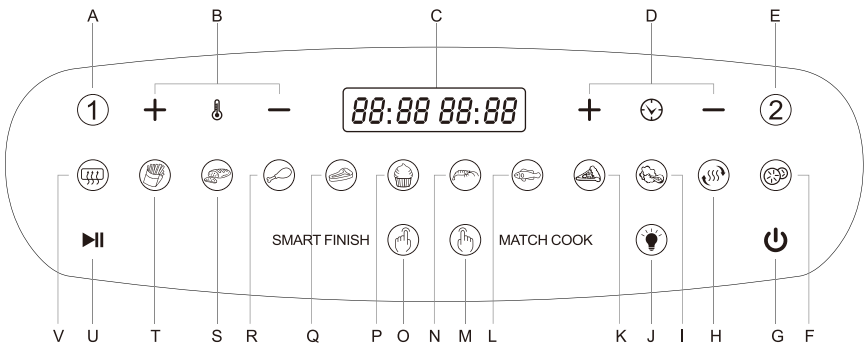
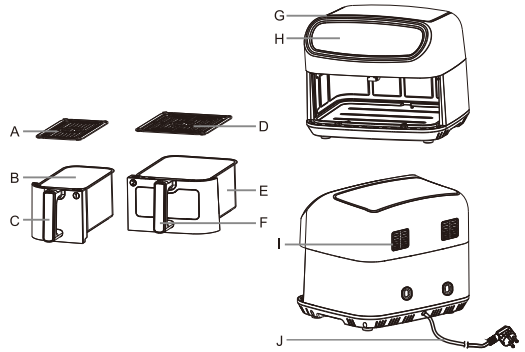

- A: Zone1 B: Temperature plus/minus C: Timer/temperature Display
- D: Timer plus/minus E: Zone 2 F: Dehydrate G: ON/OFF
- H: Reheat I: Vegetable J: Lamp K: Pizza L: Fish M: Match cook
- N: Shrimp O: Smart finish P: Cake Q: Steak R: Drumsticks
- S: Meat T: French fries U:Start/Pause V: Pre-heat

Important information

Please read this user manual carefully before the use of the appliance and keep it safely for future reference.

Danger

- Never immerse the housing, which contains electrical components and the heating elements, in water and rinse it under the tap.
- Do not let any water or other liquid enter the appliance in order to prevent electric shock.
- Always put the ingredients to be fried in the tray, so as to prevent it from coming into contact with the heating elements.
- Do not cover the air inlet and the air exhaust openings while the appliance is operating.
- Do not fill the frying tray with oil as this may cause a fire hazard.
- Never touch the inside of the appliance while it is operating.
- Check whether the voltage indicated on the appliance corresponds to the local mains voltage in your country before you connect the appliance.
- Do not use the appliance if the plug, the power cord or the appliance itself is damaged.
- If the power cord is damaged, you must have it replaced at a service center authorized by similarly qualified persons in order to avoid a hazard.
- This appliance is not suitable for children or people who are either physically or mentally handicapped or those who lack experience and knowledge. If you want anyone else to use the appliance, that person should be properly guided on its use.
- Keep the appliance and its mains cord out of the reach of children when the appliance is switched on or is cooling down.
- Keep the main cord away from hot surfaces.
- Do not plug in the appliance or operate the control panel with wet hands.
- Only connect the appliance to an earthed wall socket, and always make sure that the plug is inserted into the wall socket properly.
- Never connect this appliance to an external timer switch.
- Do not place the appliance on or near combustible materials such as a tablecloth or curtains.
- Do not place the appliance against a wall or against other appliances; Leave at least 10cm free space at the back and sides and 10cm free space above the appliance; Do not place anything on top of the appliance.
- Do not use the appliance for any purpose other than what described in this manual.
- Do not let the appliance have an unattended operation.
- During hot air frying, hot steam is released through the air exhaust openings; Keep your hands and face at a safe distance from the steam and the air exhaust openings; Be careful of hot steam and hot air when you remove the frying tray from the appliance.
- The surface below the appliance may become hot during use.
- Immediately unplug the appliance if you see dark smoke coming out of the appliance; Wait for the smoke emission to stop before you remove the frying tray from the appliance.

Caution

- Place the appliance on a horizontal and stable surface.
- Always unplug the appliance after use.
- Let the appliance cool down for about 30 minutes before you handle or clean it.
- Remove burnt remnants.
- This appliance is intended for normal household use only. It is neither intended for use in environments such as staff kitchens, offices, farms or other work environments, nor intended to be used by clients in hotels or other similar environments.
- If the appliance is used improperly or if it is not used according to the instructions in the user manual, the warranty becomes invalid and seller refuses any liability for any damage that may be caused.

Prior to the first use

1. Remove all packing materials.
2. Remove any stickers or labels from the appliance, other than the rating label.
3. Thoroughly clean the frying tray, with hot water and some liquid washing soap using a non-abrasive sponge.
Note: You can also clean these parts in the dishwasher.
4. Wipe the inside and outside of the appliance with a moist cloth.

Preparing for use

1. Place the appliance on a stable, horizontal, and heat-resistant surface.
2. Place the crisper rack in the frying tray properly.

Do not fill the frying tray with oil or any other liquid.





Do not put anything on top of the appliance. This disrupts the airflow and affects the air-frying result.

Using the appliance

1. Power on



Plug in, there is BEEPS sounds. Light up. 1 seconds will be back to standby mode: all light will be off expect  .

Zone1 or Zone2 works individually.

Plug in, it is at the standby mode. press  , Then press  or  , select cooking function. you can adjust the time and temperature freely by using Time +/- and Temperature +/- button. You can also press any function icon to cook different food. then press  unit start to work.

Zone1 and Zone2 works at the same time.

1). Plug in, it is at the standby mode. press  , Then press  , select cooking function. you can adjust the time and temperature freely by using Time +/- and Temperature +/- button. You can also press any function icon to cook different food.

2). After finish  function, press  and select cooking function. you can adjust the time and temperature freely by using Time +/- and Temperature +/- button. You can also press any function icon to cook different food.

3) .After finish above program then press  unit start to work. Every function have its own default time and temperature (As shown in the table). Customer can adjust the time and temperature freely by using Time +/- and Temperature +/- button.





Remark: use of lamp 

When the machine is in working or standby state, press the button of lamp, zone 2 will light up, the lamp will automatically turn off after 3 minutes, or can be switched on at any time .

The temperature control range is 50-200°C, every click on the + / - temperature will increase or reduce 10°C. At 200°C, , press the "+", will loop back to a temperature of 50°C, press the "-" at 50°C temperature will cycle back to 200°C. In the process of temperature control, temperature digital display will flicker on the screen (not flashing during working), after flickering 3 times, the temperature has been done of setting;

The adjusting time range is 1 to 60 mins. every click on the + / - time will increase or reduce 1 min. At 60 min if you press "+", the time will cycle back to 01 min,. At 01 min , if you press "-", the temperature will cycle back to 60 min. In the process of time control, time digital display will flicker on the screen (not flashing during working), after flickering 3 times, the time has been done of setting.

3. Start, pause/stop

After select function ,set the right time and right temperature, press  , the  start to flicker, after BEEPS sounds, machine start to work. During the machine working, press  , after BEEPS sounds,machine stop working, 

stop flickering.during the machine working,press  , after BEEPS,machine stop working,and machine back to standby mode.

Noted:

(1). During working, you can take frying tray out, stop working,and you can check cooking result or add more food, machine continue to work on the program if pull in the frying tray.

4. End of program

Heating element stop working when working time is done ,show 00 min,motor continues to work, buzzer warning. motor continues to work 1 min,cooling machine, then machine enter the standby mode.

Smart Finish

SMART FINISH



MATCH COOK

Cooking 2 foods using 2 different functions, temps or cook times?

Problem each zone and use SMART SET to have both zones finish at the same time.

Step1: Program Zone1

Place food in basket

press ①

Select a cooking function

Step2: Program Zone2

Place food in basket

Press ②

Select a cooking function

Step3: Begin cooking

Select Smart Finish

Press ►|| to begin cooking

Match Cook

SMART FINISH



MATCH COOK

Cooking the same food in each zone?

Set Zone 1 and use MATCH COOK to automatically match settings to zone 2.











Step1: Select MATCH COOK

Place food in basket

Step2: Select a cooking function

Press ►|| to begin cooking.

Menu table

program logistics			
	menu	Default time(min)	Default temperature (°C)
Function	 Pre-heat	3	180
	 French fries	18	200
	 Drumsticks	20	200
	 Steak	12	180
	 Cake	25	160
	 Shrimp	8	180
	 Fish	10	180
	 Pizza	20	180
	 Vegetable	10	160
	 Reheat	15	150
	 Dehydrate	360(Adjustable time: 0.5 hour to 24 hours)	60

Caution: Do not touch the pan during and about 30mins after use, as it gets very hot. Only hold the pan by the handle.

Operation step

1. Put the mains plug in an earthed wall socket.
2. Put the ingredients into the frying tray.
3. Put the frying tray in the right position; Choose function from menu and press START/PAUSE to start cooking.

4. Screen display

It will show temperature and time. Temperature is the setting temperature and time is remaining working time.

The function we have selected is flicker.

5. Some ingredients require shaking halfway through the preparation time (see section 'Settings' in this chapter). To shake the ingredients, you can pull the frying tray out of the appliance by the handle and shake it. Then, you can slide the frying tray back into the air fryer.

6. When you hear the timer bell, the set preparation time has elapsed. You can pull the pan out of the appliance and place it on a heat-resistant surface.

7. Check whether the ingredients are ready.

If the ingredients are not ready yet, you can simply slide the frying tray back into the appliance and cook it extra minutes.

8. Empty the tray into a bowl or onto a plate.

Tip: To remove large or fragile ingredients, you can use a pair of tongs to lift the ingredients out of the tray.

9. When a batch of ingredients is ready, the air fryer is instantly ready for preparing another batch.

Note: When you use the Air Fryer for the first time, a slight smoke or odor may be emitted. This is normal and will soon disappear. It is essential to ensure that there is sufficient ventilation around the Air Fryer.

Settings

Apart from the preset menu, you also can use this air fryer to make other food by setting the time and temperature. This table below helps you to select the basic settings for the ingredients you want to prepare.

Note: Keep in mind that these settings are only for reference. As ingredients differ in origin, size, shape and brand, we cannot guarantee the best setting for your ingredients.

Because the Rapid Air Technology instantly reheats the air inside the appliance, pulling the frying tray briefly out of the appliance during hot air frying barely disturbs process.

Cooking Tips

Air Fryer and Parts will become hot during the cooking process.

Do not over fill Fry tray with foods.

Do not pack foods into Fry tray.

Using Oil

Adding a small amount of oil to food can make them crispier.

Oil sprays are good for applying small amounts of oil evenly to food.

Food Tips

You can air fry frozen food that can be baked in the oven.

To make cakes, hand-pies, or any foods with filling or batter, you can place foods in heat-safe container and put that in Fry Tray.

Pat dry foods with marinades before adding to Fry Tray.

Reheating Foods

Simply set temperature to 150°C for up to 10 minutes.

COOKING GUIDE – Note: these settings are a guide. As ingredients differ in size shape and brand, you may need to adjust cooking times and temperatures.

Note: *It is better to add 3 minutes to the preparation time before you start frying if the appliance is cold*

Cleaning

Clean the appliance after every use.

The frying tray, rack and the inside of the appliance have a non-stick coating. Do not use metal kitchen utensils or abrasive cleaning materials to clean them, as this may damage the non-stick coating.

1. Remove the mains plug from the wall socket and let the appliance cool down.

Note: *Remove the frying tray to let the air fryer cool down more quickly.*

2. Wipe the outside of the appliance with a moist cloth.

3. Clean the frying tray and rack with hot water, some washing liquid soap and a non-abrasive sponge.

You can use a washing liquid to remove any remaining dirt.

Note: *The frying tray and rack are dishwasher-proof.*

Tip: If dirt is stuck to the rack, or at the bottom of the frying tray, fill the frying tray with hot water and with some washing liquid soap. Put the rack in the frying tray and let the frying tray and the rack soak for approximately 10 minutes.

1. Clean the inside of the appliance with hot water and a non-abrasive sponge.

2. Clean the heating element with a cleaning brush to remove any food residues.

Storage

1. Unplug the appliance and let it cool down.

2. Make sure all parts are clean and dry.

Troubleshooting

Problem	Possible cause	Solution
The air fryer does not work	The appliance is not plugged into the mains.	Put the mains plug in an earthed wall socket.
	You have not set the timer.	Turn the timer knob to the required preparation time to switch on the appliance.
Food not fully cooked	The amount of the ingredients in the Frying Tray is too much.	Put smaller batches of ingredients in the Frying Tray. Smaller batches are fried more evenly.
	The set temperature is too low.	Turn the temperature control knob to the required temperature setting (see section 'Settings').
	The preparation time is too short.	Turn the timer knob to the required preparation time (see section 'Settings').
The ingredients are fried unevenly in the air fryer.	Certain types of the ingredients need to be shaken halfway throughout the preparation time.	Ingredients that lie on the top of or across each other (e.g. fries) need to be shaken halfway throughout the preparation time (see section 'Settings').
Fried snacks are not crispy when they come out of the air fryer	You use a type of snack meant to be prepared in a traditional deep fryer.	Use oven snacks or lightly brush some oil onto the snacks for a crispier result.
Cannot slide the pan into the appliance properly.	There is too much food in the Frying Tray.	Do not fill the tray beyond the maximum amount indicated in the table on the earlier page.
White smoke comes out of the appliance	You are preparing greasy ingredients.	Note that the temperature is well-controlled to be under 180°C, when you fry greasy ingredients in the air fryer.

Problem	Possible cause	Solution
	The pan still contains greasy residues from the previous use.	White smoke is caused by grease heating up in the pan. Make sure you clean the pan properly after each use.
Fresh potato fries are fried unevenly in the air fryer.	You did not soak the potato sticks properly before you fried them.	Soak the potato sticks in a bowl of water for at least 30 minutes; take them out and dry them with kitchen paper.
	You did not use the right potato type.	Use fresh potatoes and make sure they stay firm during frying.
Fresh potato fries aren't crispy when they come out of the air fryer.	The crispiness of the fries depends on the amount of oil and water in the fries.	Make sure you dry the potato sticks properly before you coat them with oil.
		Cut the potato into thinner sticks for a crispier result.
		Add slightly more oil for a crispier result.